

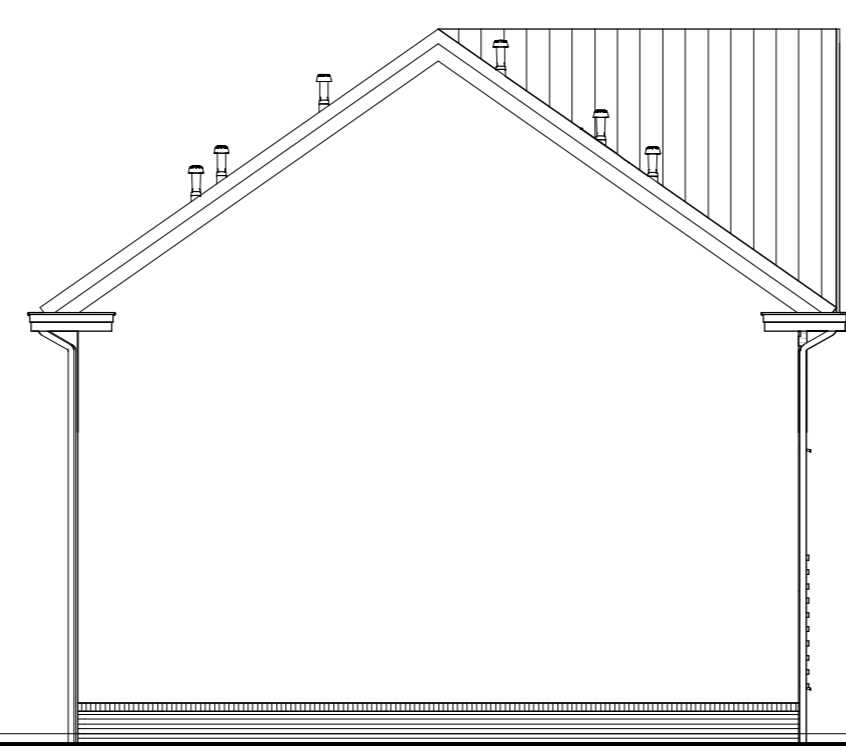

Kavel 177 Kavel 178 Kavel 179 Kavel 180 Kavel 181

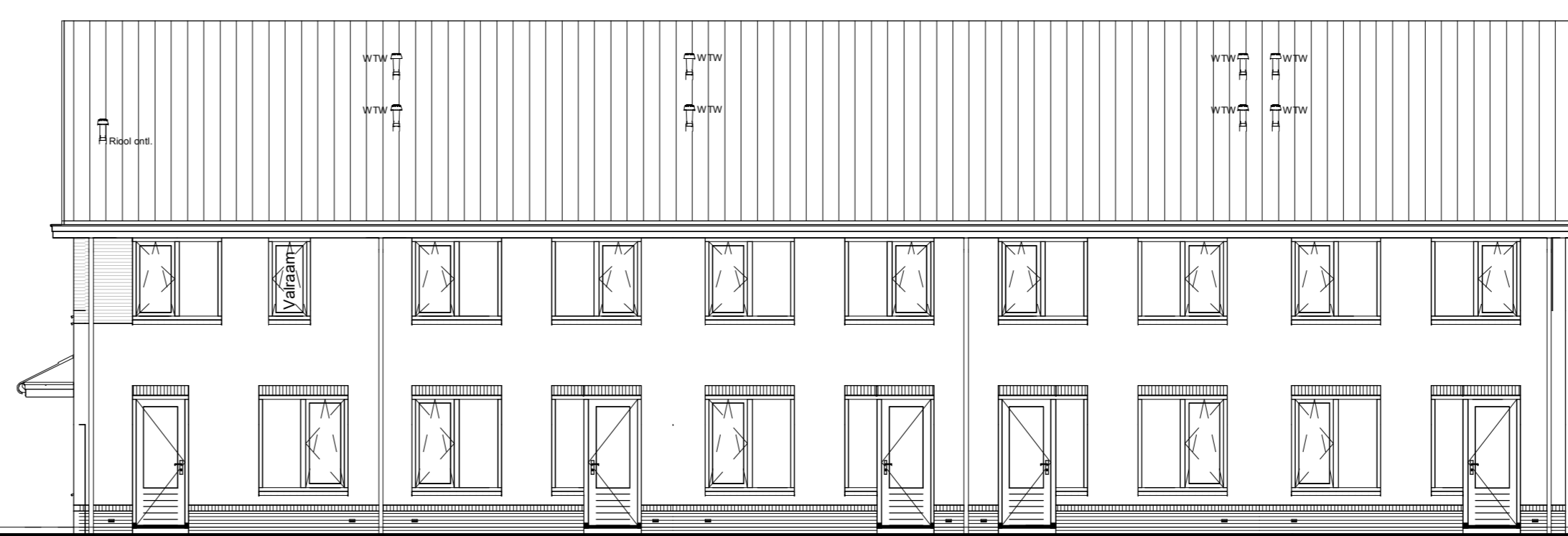

Kavel 177



Kavel 181 Kavel 180 Kavel 179 Kavel 178 Kavel 177

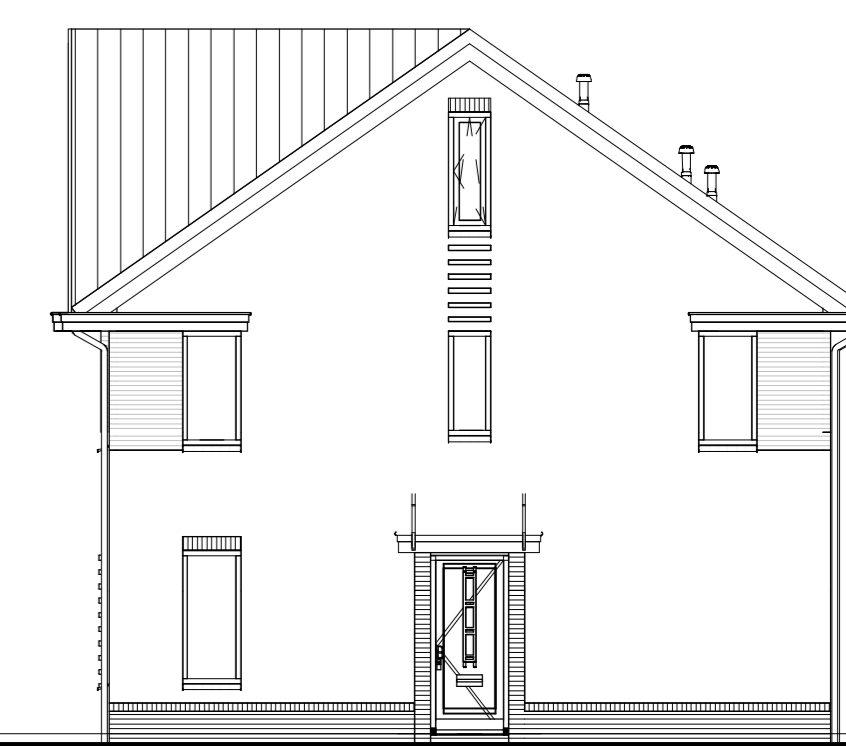

Kavel 181

Voorgevel

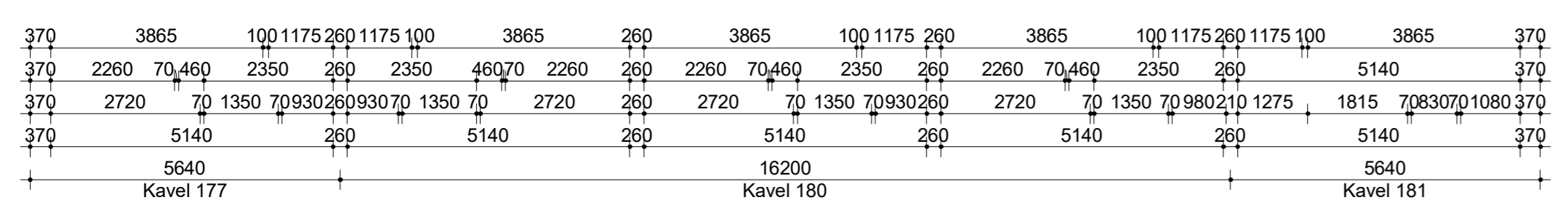
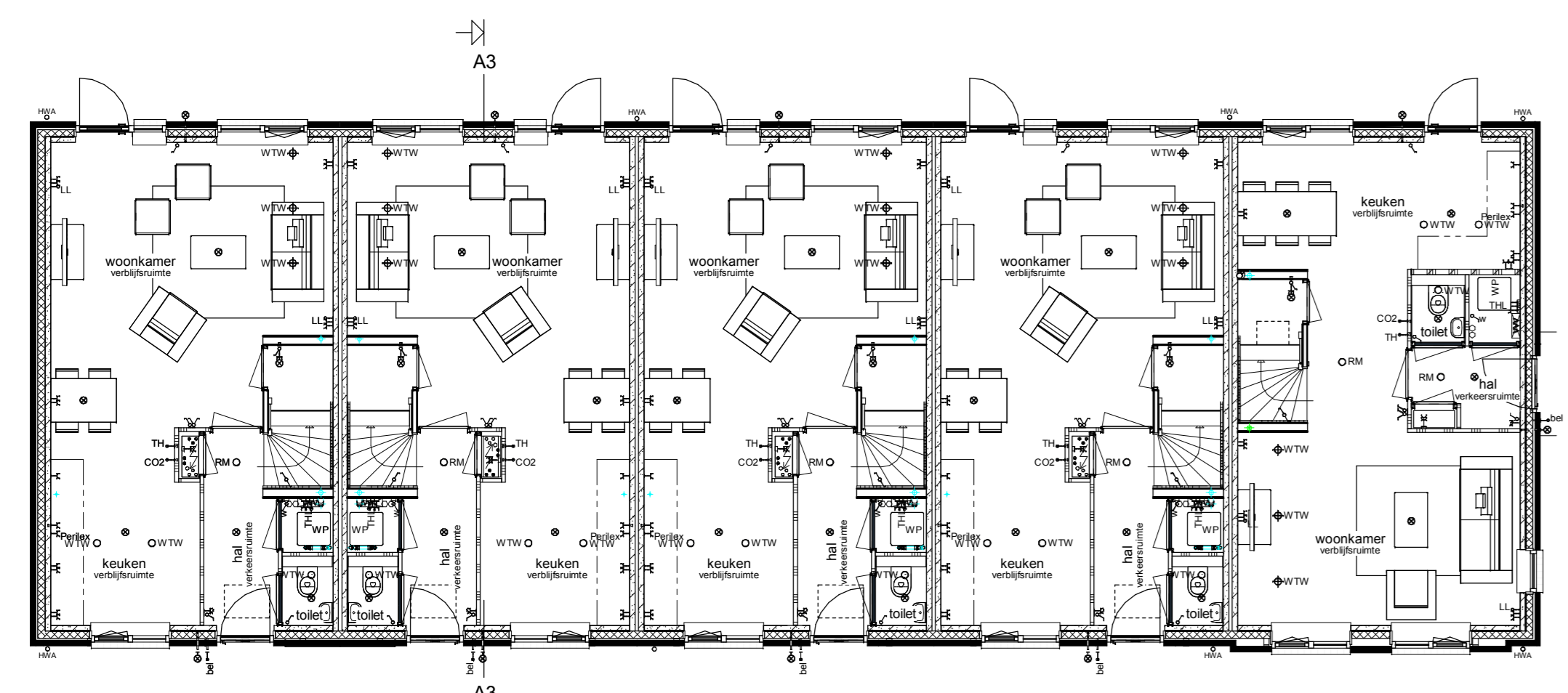

Begane grond

Linker zijgevel

Achtergevel

Rechter zijgevel

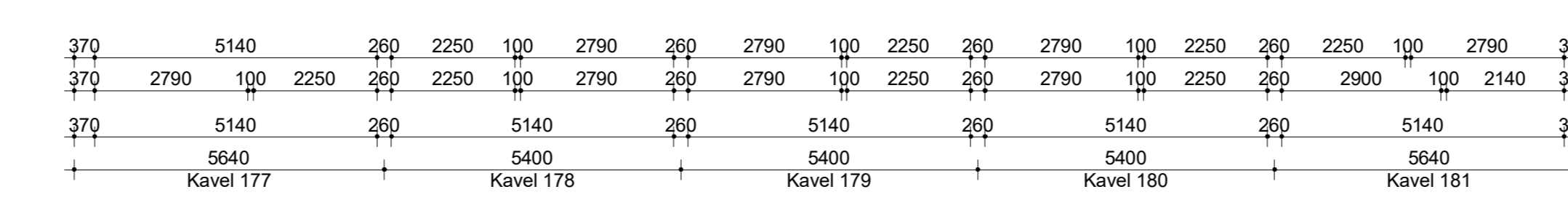
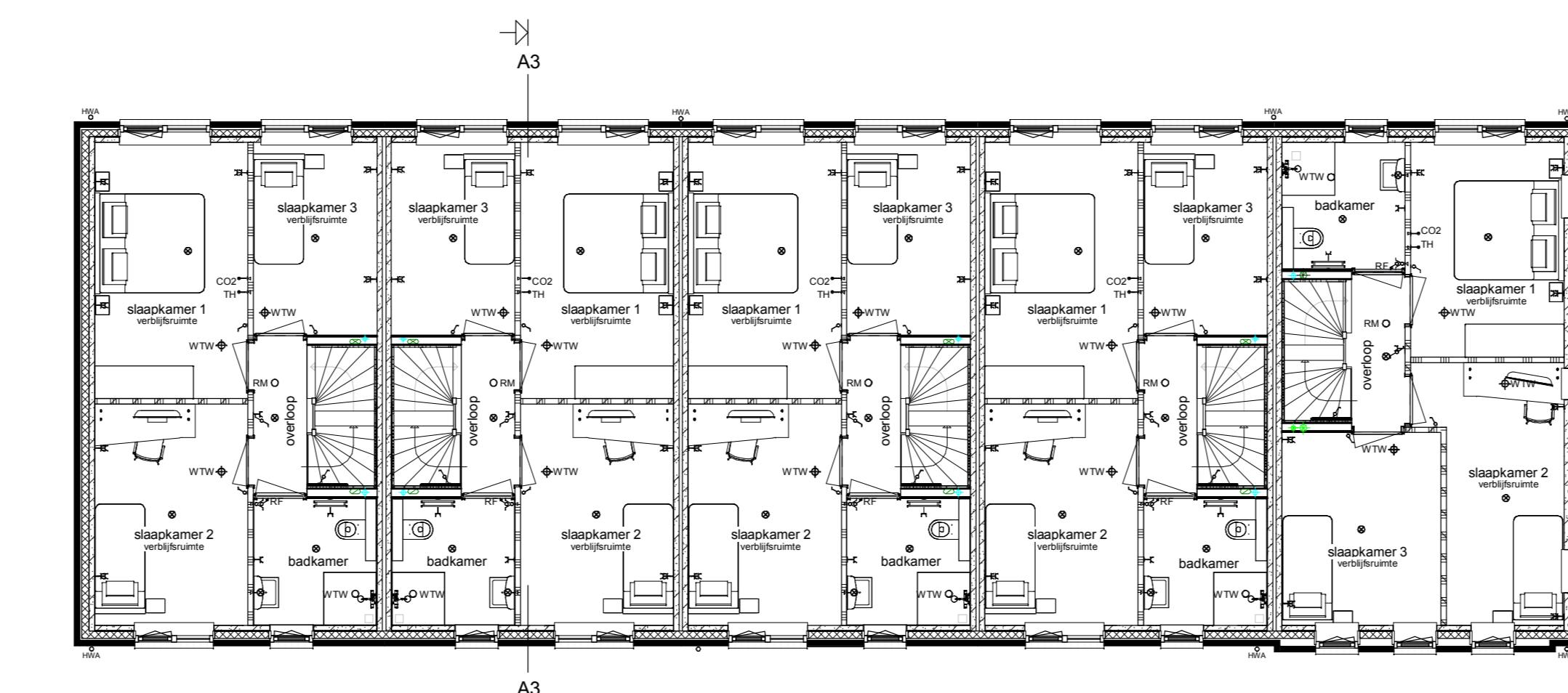

Verdieping

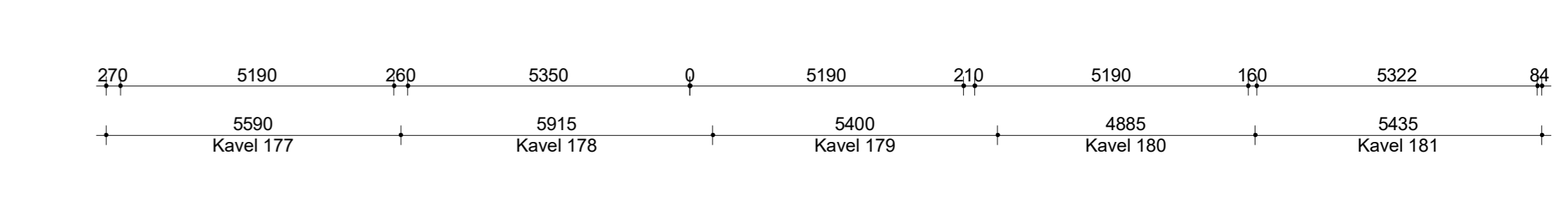
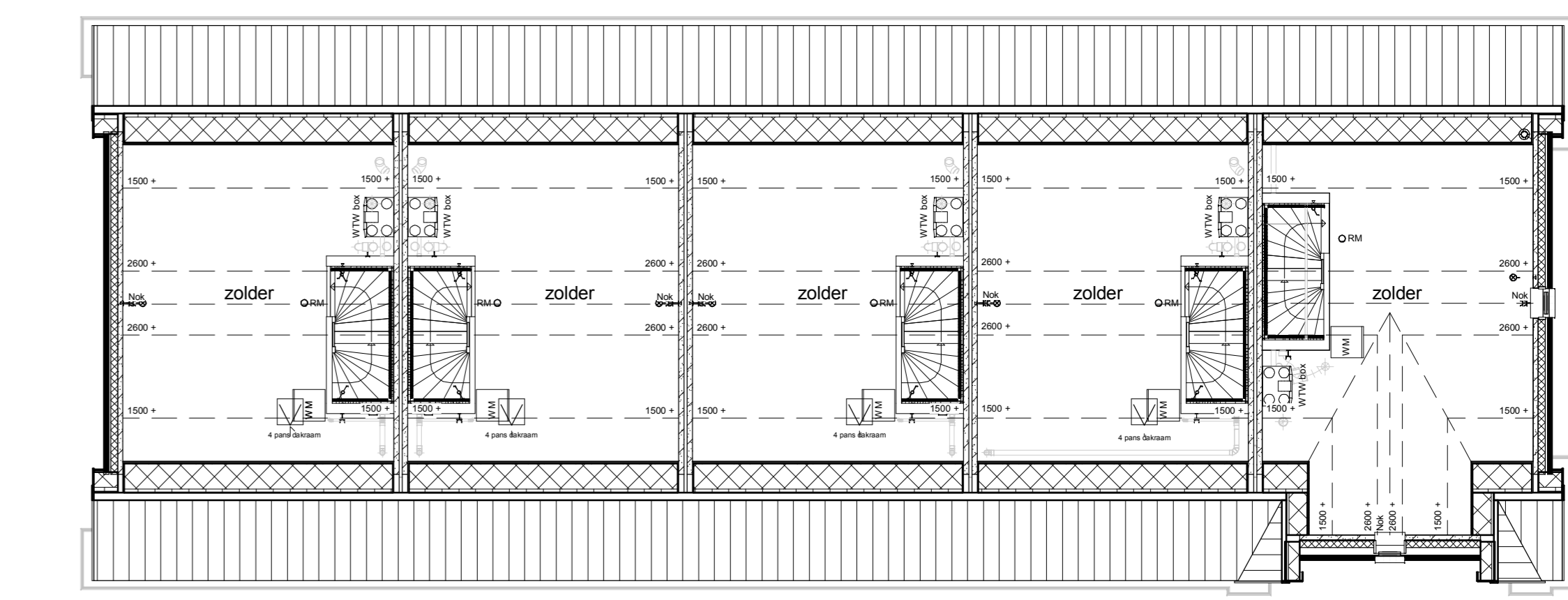

Zolder

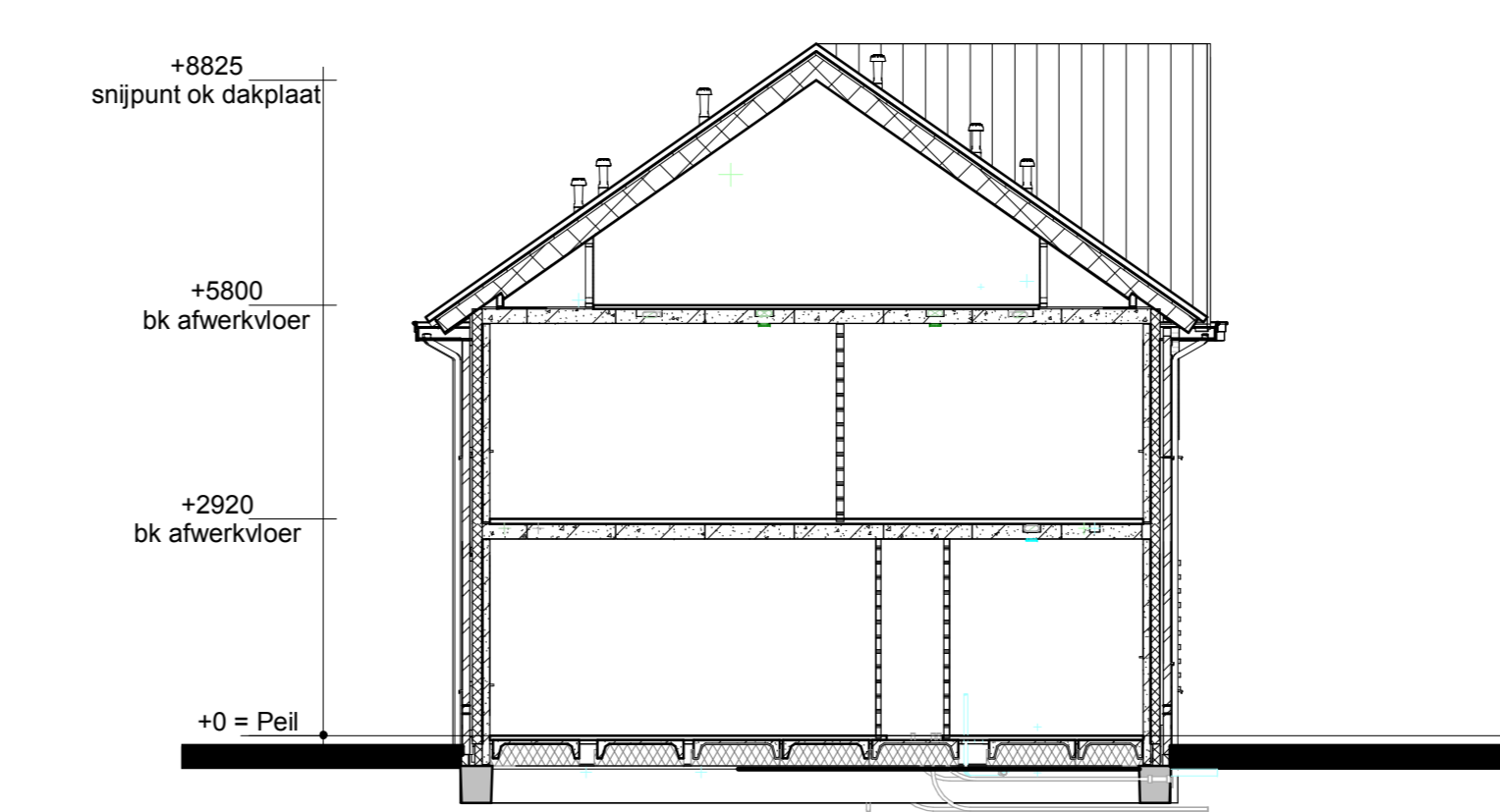

Doorsnede A3

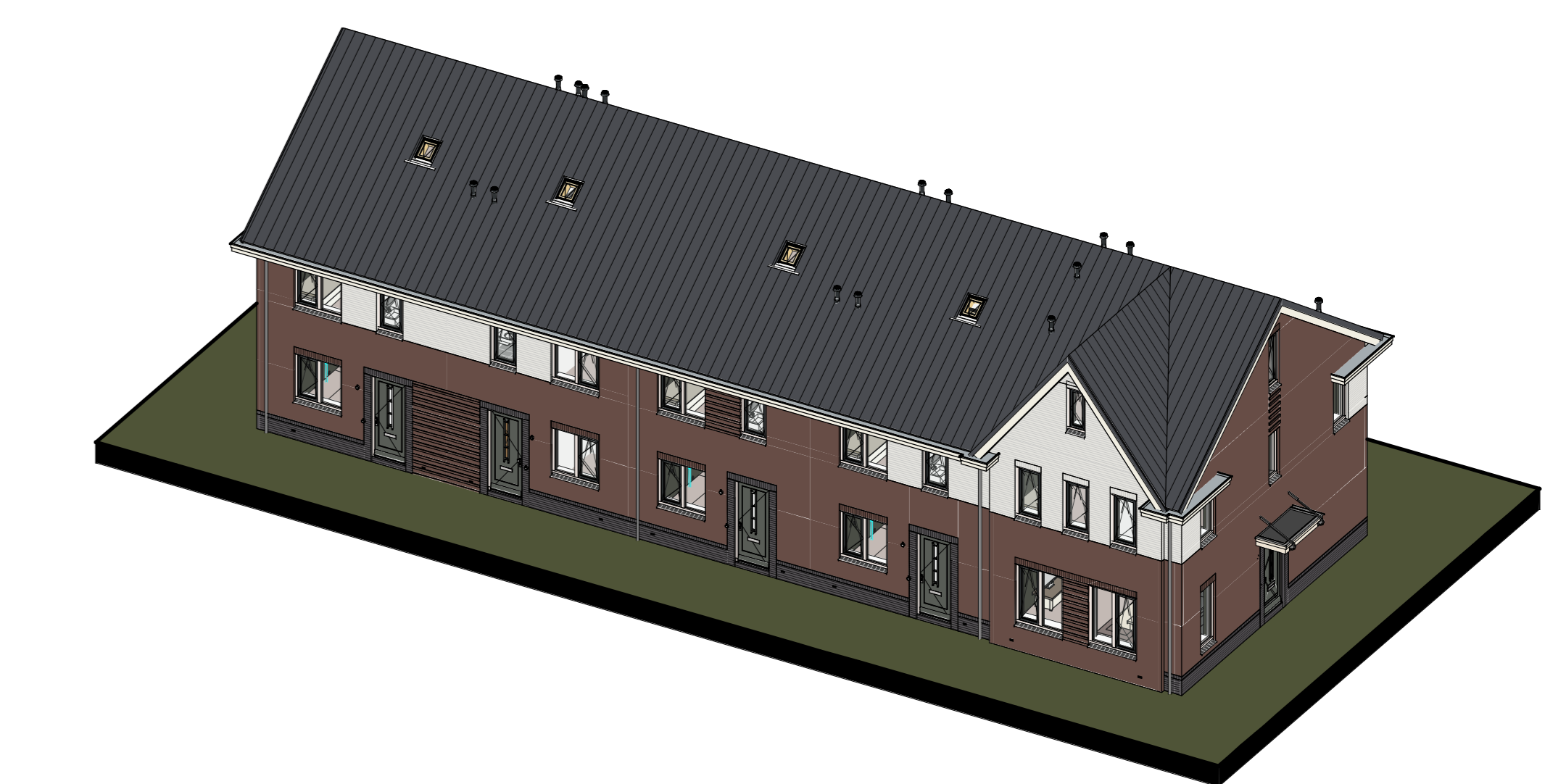

Renvooi

- Metselwerk
- Isolatie
- Betonnen wand
- Kalkzandsteen wand
- Lichte scheidingwand
- Dragend kieschot incl. afheembaar paneel ipv kruis
- Vloerverwarmingverdelers
- BTU box
- Warmtepomp
- Meterkast
- Kruipkluk
- Opstelplaats wasmachine
- Radiator
- Enkele schakelaar
- Dubbele schakelaar
- Wisselschakelaar
- Standen schakelaar lb.v. ventilatiesysteem
- Enkele wandcontactdoos met randaarde
- Dubbele wandcontactdoos gesaad (Boven elkaar)
- Dubbele wandcontactdoos gesaad (naast elkaar)
- Plafondlichtpunt
- Wandlichtpunt
- Roommelder
- BTU retourventiel
- BTU retourventiel wand
- BTU retourventiel wand
- Thermostaat
- Loze leiding
- Bel
- CO2 bedieningspaneel
- CAI aansluitpunt t.b.v. kabel
- HWA

opdrachtgever gevoelens	titel 177-181	177-181
Bouwovereenkomst	PROJECT	16 woningen type "Hoge heren" In het plan "Lombok Zuid, fase 9" te Eerbeek
<b>IDENTIS</b> DOOR ROOSDOM TIJHUIS	OPDRACHTGEVER	Bouwbedrijf Roosdom Tijhuis bv
	ONDERNEEMER	Verkooptekening kavel 177-181
	ARCHITECT	M. sc. B.A.W. Nijland
	SCALE	1:100
	DATE	31-03-2022
	VERSION	V-01c
	NO.	5953